

Data Sheet



Article number: 021816025150

Description: Clamp with bracket and rubber
SPGU 6025. 150/30 SK

Measures

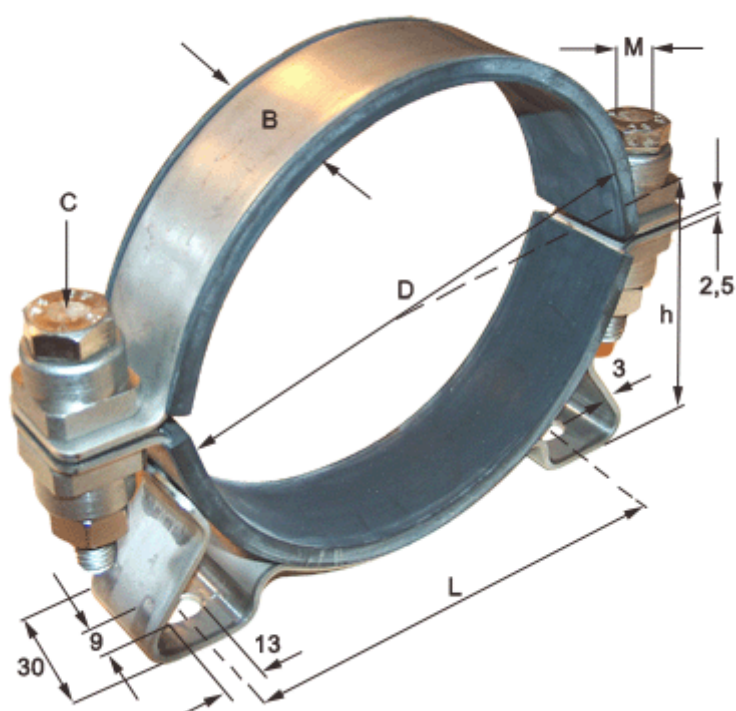

C (screw type) = SK hexagon screw

Diameter D = 150

h = 83

L = 136

Width B = 30